

FLAME

“CURVES”

ANALOG RESONANCE FILTERBANK

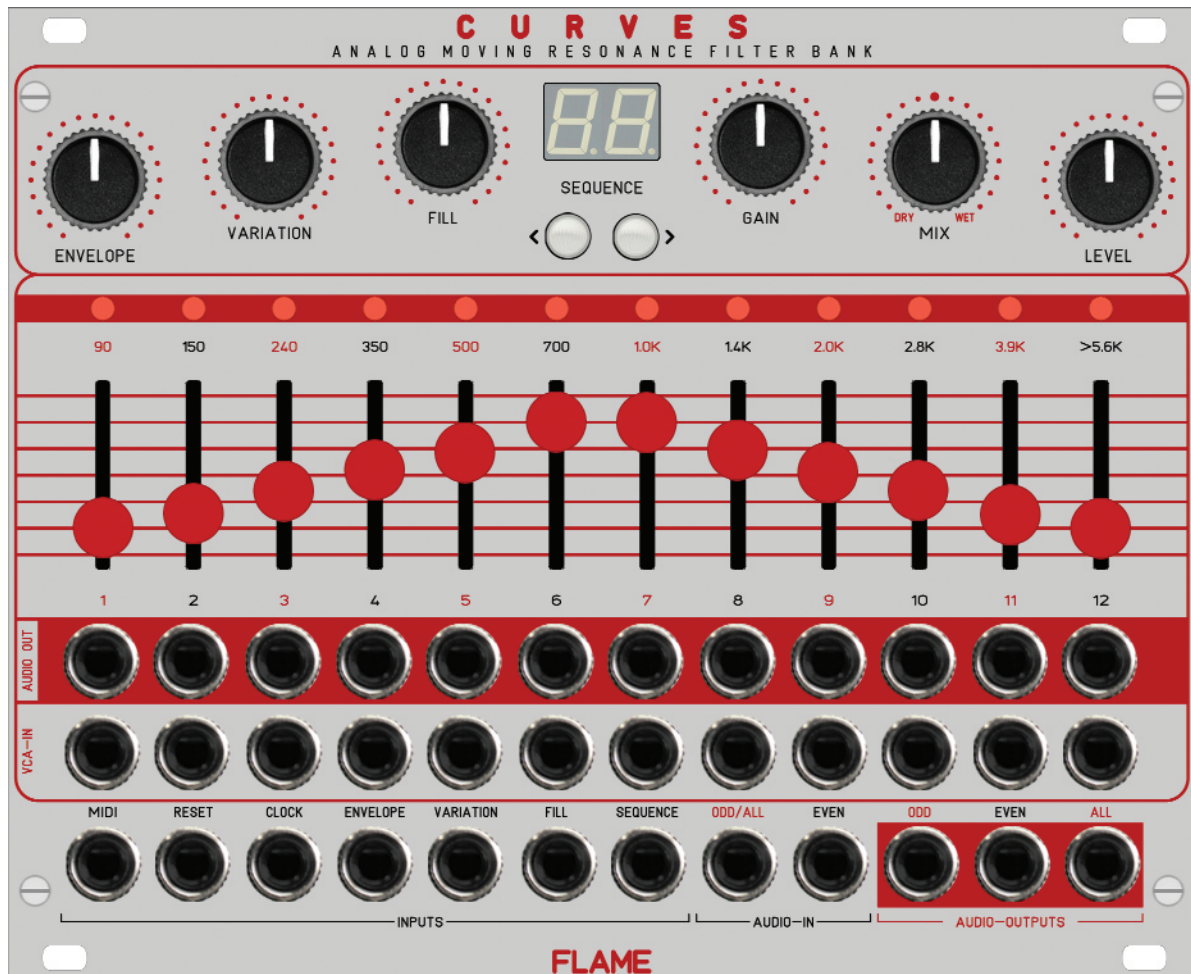

MANUAL

Version 2.00

Contents

1. Short description.....	3
2. Hardware / connections.....	4
2.1 Connection to the modular system (Doepfer bus)	4
2.2 Module overview	5
2.3 MIDI connections	6
2.4 AUDIO schemes	7
3. Filterbank	8
3.1 Structure of the filter bank	8
3.2 Structure of the filter channel	9
3.3 Filter bank control	10
3.4 MODE Sequence	11
- Knob ENVELOPE	12
- Knob VARIATION	13
- Knob FILL	13
3.5 MODE Manually	14
- FILTERTYPE	14
- CUTOFF	15
- SMOOTH	15
4. MIDI functions	16
4.1 Overview	16
4.2 Sync per MIDI	16
4.3 Play filter channels with note commands	16
4.4 Program Change	16
4.5 Control Change (Parameter control)	17
5. Firmware update	18
6. Appendix and technical informations	19
6.1 Technical details	
6.2 Warrenty	
6.3 Terms of production	
6.4 Disposal	
6.5 Support	
6.6 Acknowledgment	

1. Short description

The "Curves" Euro Rack Module is an analogue 12-channel filter bank with 24dB filters and an integrated modulation sequencer (external clock only) with a wide range of control options. The controllers of the sequencer can be used to influence the pattern but also to control the filter channels manually (or via CV).

The filter channels are each divided into two channels (odd/even) and can be operated separately in stereo or together in mono. There are two inputs for odd(mono)/even, as well as two individual outputs for odd/even and a mono sum channel including dry-wet mix control and level control.

Each of the 12 filter channels also has a separate VCA input (0..+5v) and a separate individual audio output. The filter channels can also be played separately with velocity using MIDI notes.

The modulation sequencer offers a variety of options. It can be synchronized with an external clock (16th note) either via MIDI clock or analog via trigger and reset inputs.

There are 99 memory locations available, into which a maximum of 99 four-bar patterns can be loaded. The patterns are selected either directly by button, by MIDI program change or by CV input "SEQUENCE".

With the help of the Curves Editor (PC or MAC version) the patterns can be edited and loaded into the module. The sequencer is a midi sequencer in tick resolution with settings for gate time, velocity, track last step and shuffle.

All MIDI settings are made with the editor (e.g. receive MIDI channel and note numbers for the filter channels).

On the module itself there are 3 controls for influencing the pattern:

- Envelope (different envelopes in trigger or gate mode)
- Variations (random values of velocity and envelope lengths)
- Fill (turn up all filter channels)

All three functions can also be controlled by an external CV via CV inputs.

In manual mode (Sequencer=OFF), these three controls can be used to control the filter channels directly (and also via CV):

- Envelope (selection of hard detented and soft cutoff movement)
- Variations (choice of filter type: Allpass, Lowpass, Bandpass 1-3, Highpass)
- Fill (cutoff = movement/passing through the bands)

Future firmware updates can simply be loaded using a sysex dump.
A MIDI adapter cable is included.

2. Hardware / connections

2.1 Connection to the euro rack modular system (Doepfer bus)

The module is delivered with a connected ribbon cable for the Doepfer bus. The red lead marks -12 volt. Connecting the module please note the right polarity!

If the module is poled accidentally wrong safety diodes avoid the immediate destruction of the module but further damages cannot be expected.

So please pay attention: Check the connection various times before switching on!

The current consumption of the module is on average +250mA and -170mA.

CAUTION!

Do not accidentally connect the MIDI THRU output to high CV voltages! This can possibly damage the hardware!

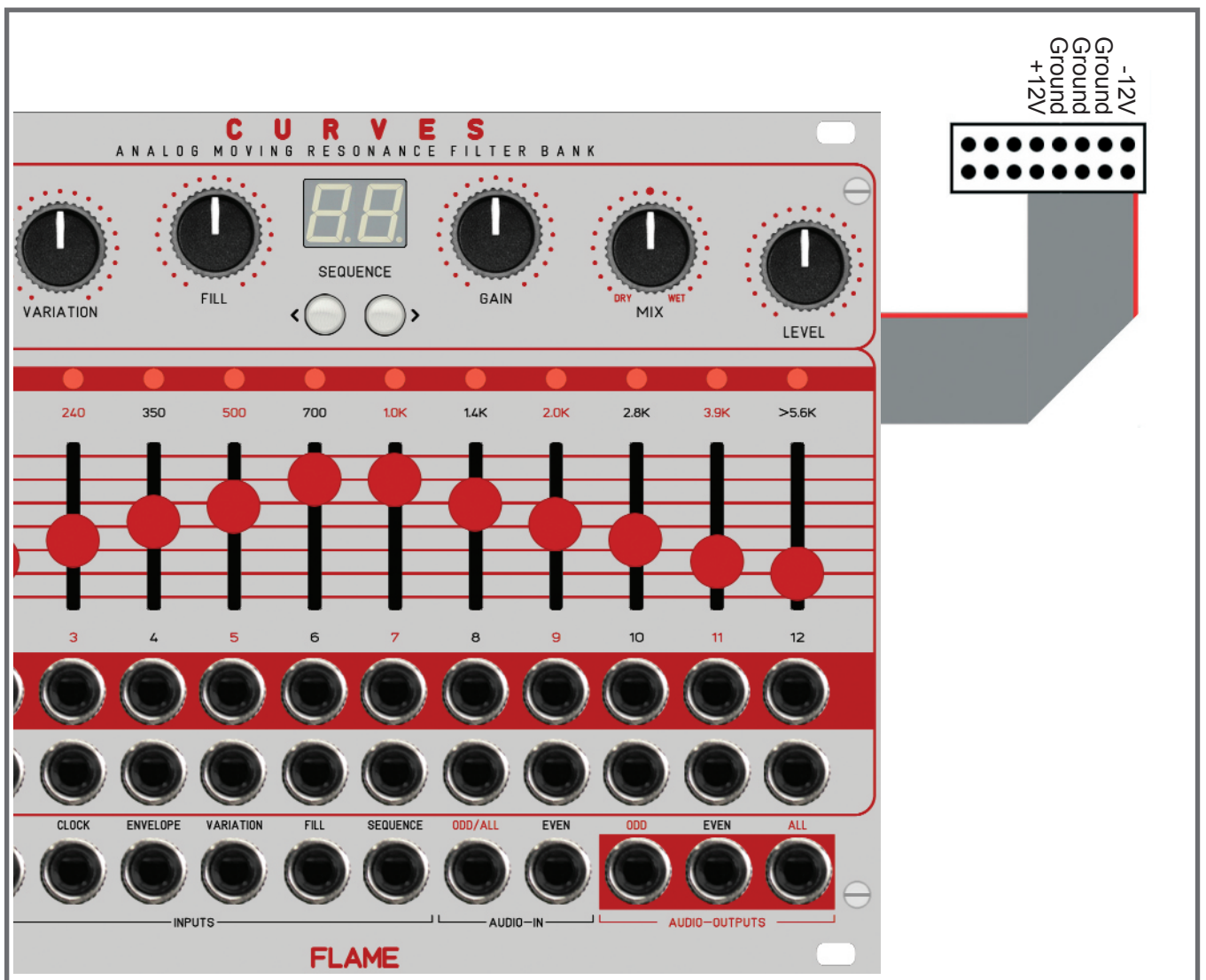

2.2 Modul overview

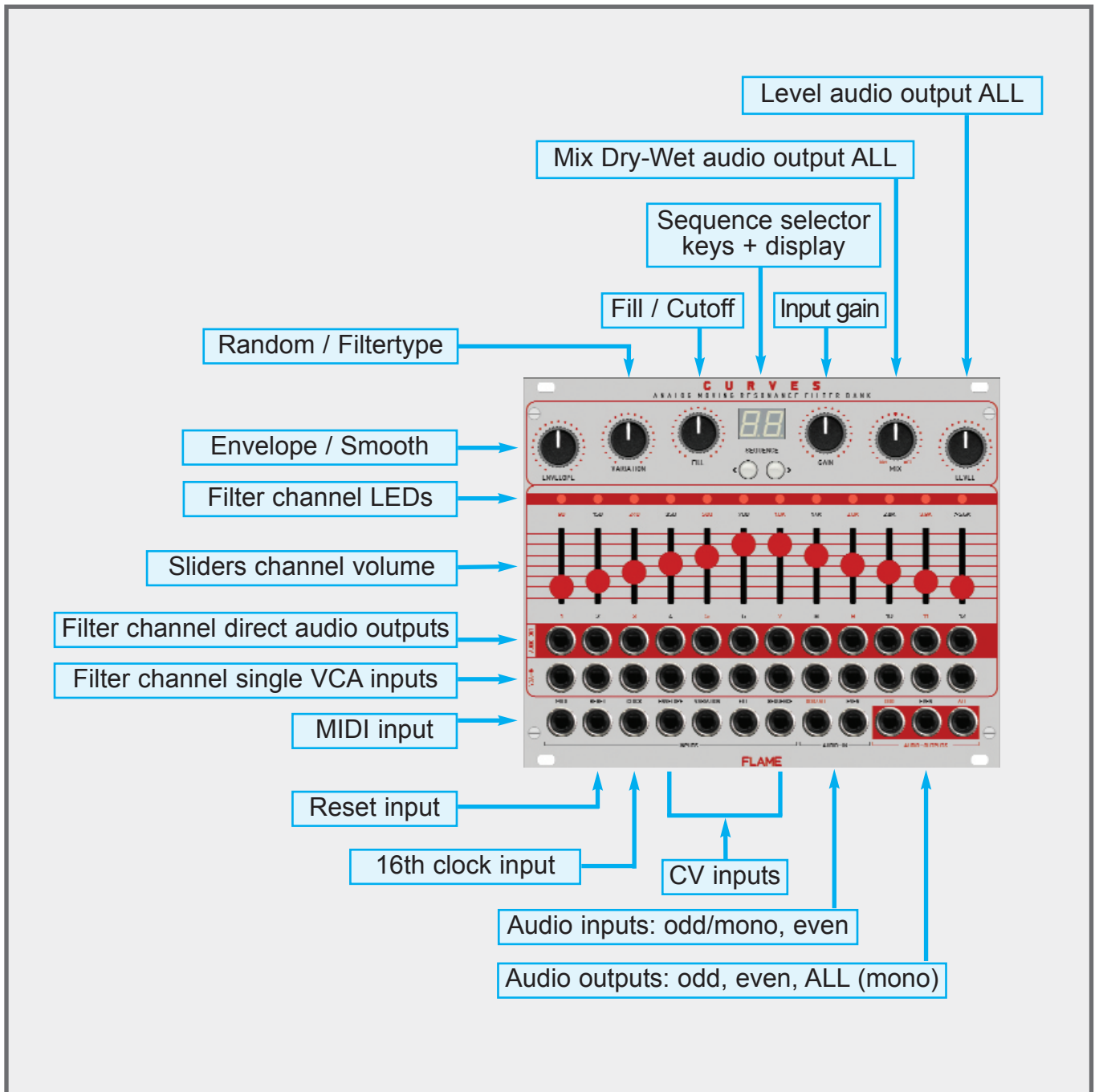

2.3 MIDI connections

The module has a MIDI INPUT socket (3.5mm mini jack in TRS-B standard) for controlling parameters, loading/editing of sequences or firmware updates via sysex. Connect the MIDI input to the MIDI output of your keyboard/controller or computer. An appropriate commercially available adapter (MIDI-DIN to Mini TRS-B) or a 3.5mm stereo jack cable is used for the MIDI connection. A corresponding adapter is included.

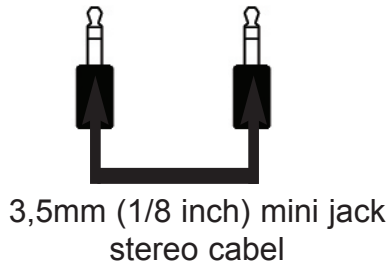

Adaptor schemata
MIDI DIN jack to
3,5mm (1/8 inch) mini jack
MIDI TRS-B standard

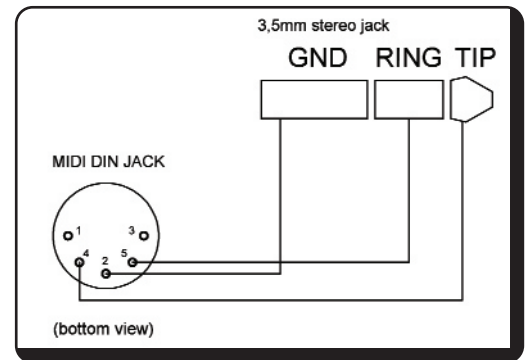

Examples of possible connections:

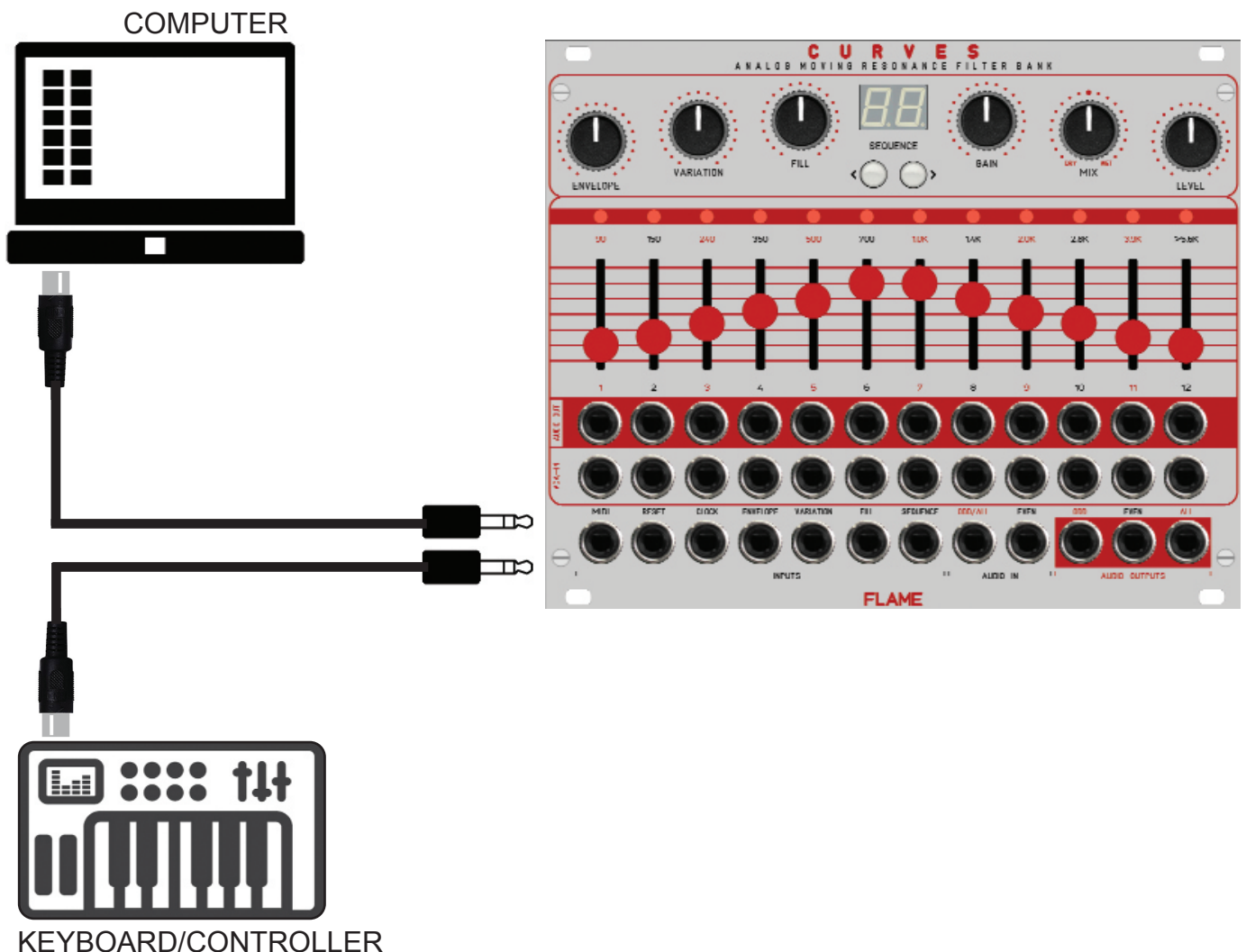

2.4 AUDIO schemes

The module has two audio inputs, which are alternately routed to the filter channels. Input ODD is routed to the odd-numbered channels and input EVEN to the even-numbered channels. If only one cable is plugged into the ODD/ALL input socket, the input signal is routed to all filter channels (ALL=mono input).

EFFECT MIX

Both inputs ODD+EVEN are routed together to the GAIN controller, which is then present as a mono signal at the MIX controller (dry) (original signal). The MIX controller controls the mixing ratio between this original signal and the effect signal (wet), which consists of the output sum of all filter channels (Mono Signal = EVEN + ODD outputs). When the MIX control is in the middle position, the volumes of the original and effect signals are approximately the same. The LEVEL control then determines the level of the mix signal at the ALL output socket.

The maximum level of both filter channel groups is always present at the two outputs ODD and EVEN. This can be viewed as the stereo output of the filter bank. The filter bank is therefore suitable for stereo applications.

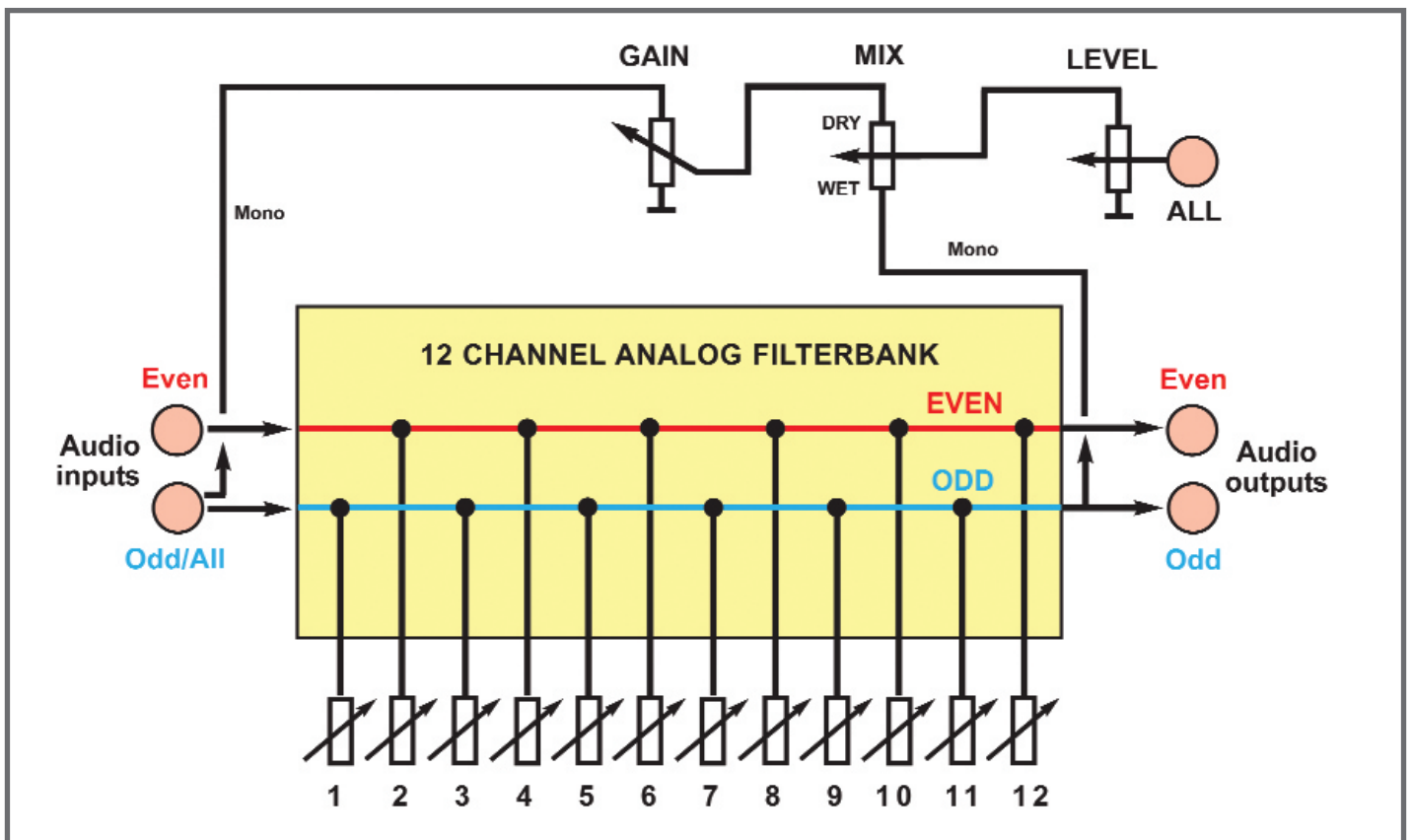

Each of the 12 filter channels has an additional audio output (modular level). The output level is independent of the slider position so that the signal can be processed externally even though it has been removed from the mix.

The sliders only serve as a manual attenuator for the corresponding channel. In order to hear a controlled sequence, the slider must be turned up. The maximum output signal is therefore determined by the position of the slider.

3. FILTERBANK

3.1 Structure of the filterbank

The module has an analog filter bank consisting of 12 filter bands. The first 11 filter bands are 24db bandpasses (resonance filters) with fixed frequencies and medium resonance, the exception being channel 12, a 24dB highpass filter that lets through all higher frequencies from around 5Khz.

The center frequencies of the channels are:

90Hz, 150Hz, 240Hz, 350Hz, 500Hz, 700Hz, 1KHz, 1.4KHz, 2KHz, 2.8KHz, 3.9KHz, >5.6KHz

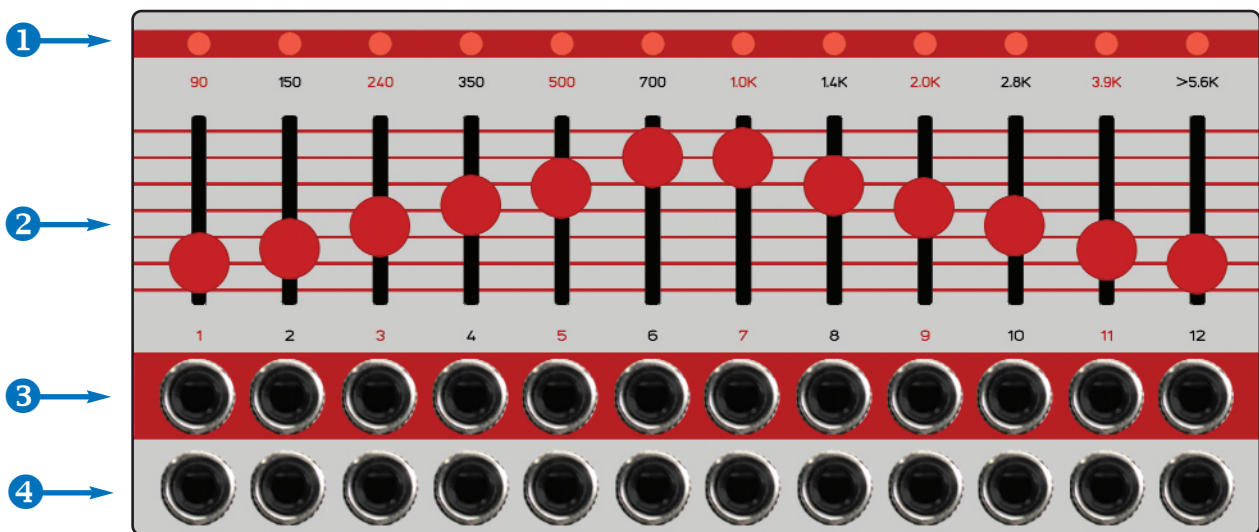

- ① **BAND LEDs** LED display VCA level of the filter band
- ② **BAND SLIDERS** Audio filter band attenuators
- ③ **BAND AUDIO OUT** Audio individual outputs of all filter bands
- ④ **BAND CV IN** CV inputs of the VCAs of the filter bands

Each filter band has an output volume slider. This allows you to lower these frequencies in the overall sound or remove them entirely. Up to this point, the filter bank resembles a graphic equalizer. But the filters in the CURVES have other properties that clearly distinguish them from an equalizer. On the one hand, there are the resonant filters that particularly amplify the range around the respective center frequencies. On the other hand, the individual frequency bands do not overlap. Therefore, the timbre is noticeably affected because it adds resonances at key points in the sound spectrum.

Each channel has a VCA for electronic volume control through the internal sequencer or separately through the BAND CV input. With a CV voltage of 0 to +5v the channel can be regulated separately. The BAND Leds signal the level of the VCA. Each channel has an additional output for the audio signal, which can be tapped independently at the socket. The channel control has no influence on the level (in order to be able to process the signal separately, even though it may have been removed from the mix).

3.2 Structure of the filter channel

The filter bank of the module has 12 filter bands.

Each of these filter bands basically consists of a fixed frequency filter (24dB bandpass or high-pass), a VCA for volume control via CV, and a slider for manually attenuating the audio signal.

The VCAs can be controlled in different ways:

- directly via channel CV input
- Filter simulations by manual controls/CV
- internal modulation sequencer

See the following chapter: "Filter bank control"

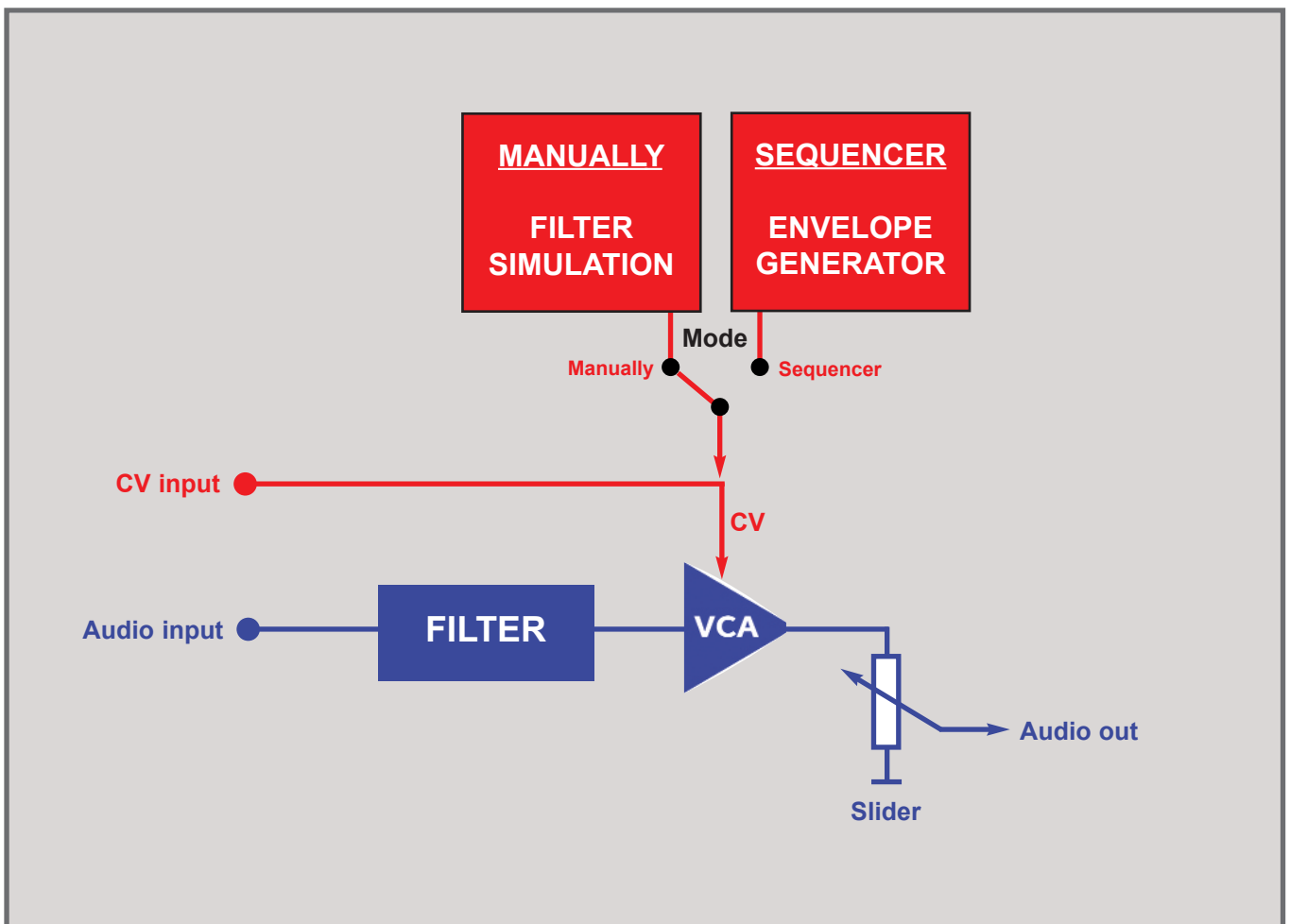

3.3 Filter bank control

In CURVES there are two different ways (MODE) to modulate the filter bank:

1. Through an internal modulation sequencer (one track for each filter band) with knobs and CV controls for envelope, variations (random) and fill mix (additive raising of all filter bands)
2. Manually with the help of a filter type simulation and with controls for cutoff, filter type and smoothing of the filter bands.

MODE SELECTION

Use the “SEQUENCE” buttons to either select a pattern “01..99” or set the display to “oF” (press the sequence button “<” until “oF” appears)

01..99 **Mode SEQUENCE** (Modulation sequencer)
oF **Mode MANUALLY** (Filter simulations)

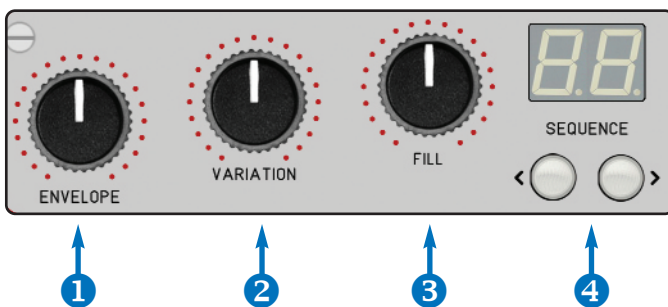

- 1 **KNOB ENVELOPE** Envelope or smoothing (passing through the filter bands)
- 2 **KNOB VARIATION** Variations (random) or Filtertype (of the filter simulation)
- 3 **KNOB FILL** Turn up the level of all filter bands or cutoff (of the filter simulation)
- 4 **SELECT MODE/SEQUENCE** Pattern or mode selection (oF=filter simulation)

The knobs have different functions in the two modes:

MODE SEQUENCE (Display 01..99)

KNOB ENVELOPE Envelopes of the sequence

KNOB VARIATION Random = Envelope/Volume Variations

KNOB FILL level of all filter bands (mix in)

MODE MANUALLY (Display “oF”)

KNOB ENVELOPE Smoothing of passing through the filter bands

KNOB VARIATION Selection of one of 6 filter types

KNOB FILL Adjust filter type cutoff

3.4 MODE SEQUENCE

To animate the filter bands rhythmically, the CURVES uses a relatively simple sequencer with 12 parallel tracks. The module has 12 envelope generators, one for each filter band, which affect the output level of the respective filter. The "shape" of the envelope (i.e. the times for attack, decay or release) depends on the "ENVELOPE" control. This allows differentiated volume curves to be generated, such as percussive sounds or slowly rising curves.

ACTIVATE SEQUENCE MODE:

Use the buttons to select a sequence between 01 and 99.

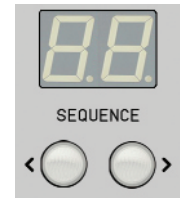

The sequencer does not have its own clock and can only be driven externally. This is done either with MIDI clock (start/stop) or via the CLOCK and RESET sockets. The analog CLOCK input requires a 16th pulse sequence. Since the sequencer runs internally at a higher resolution, the clock should run smoothly (the tempo is measured between two clock pulses). The pattern is reset with the RESET input. If no clock arrives for more than a few seconds, the sequence is stopped and reset.

The memory contains up to 99 patterns (sequences) with a maximum length of 4 bars. You can create your own patterns with the CURVES editor and transfer them to the module via MIDI. More information on this can be found in the editor's help file (see the Download section on the Flame website).

The following figure shows the editor with a loaded pattern:

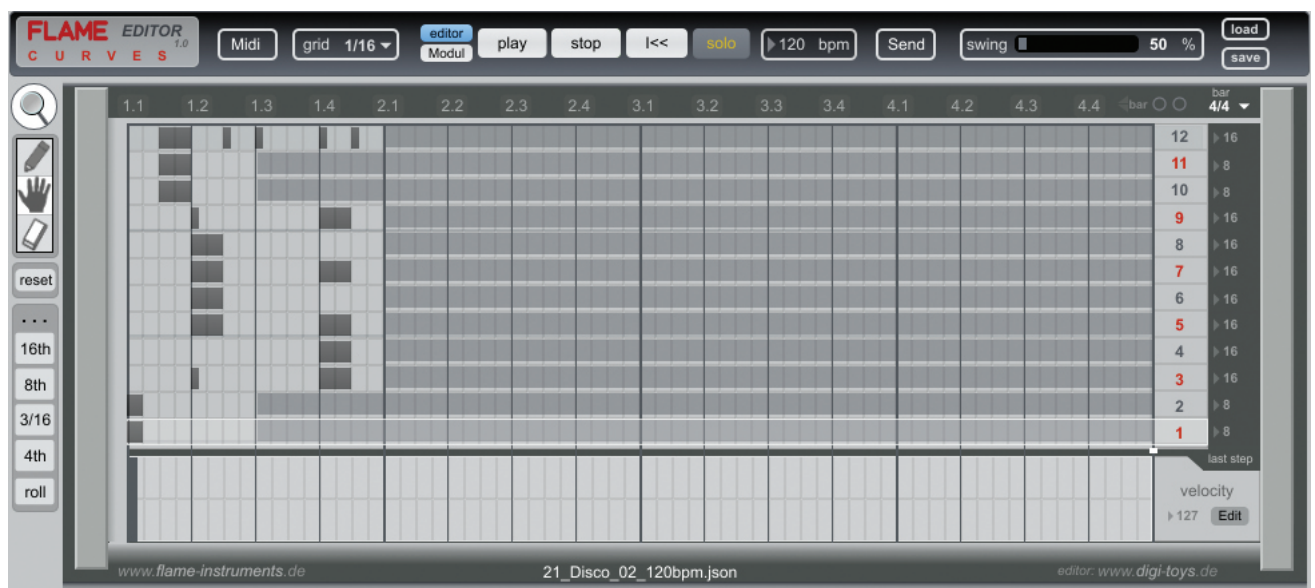

SEQUENCE MODE KNOBS & CV

The sequence played can be influenced with the three controllers at the top left:

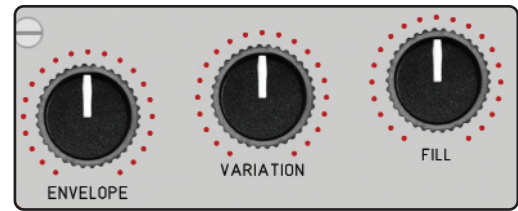

KNOB ENVELOPE

This is one of the most interesting features of the CURVES. When the sequence is played back, the controller can be used to "morph" through the different forms of the envelope.

When the knob is at ZERO, the sound is short and choppy. The attack and decay phases are very short. If the control is turned up a little, you can hear the steps decay longer (the decay gets longer). The envelope is of type AD (Attack-Decay) and is only triggered by the sequencer. The length of the step (gate time) has no influence on the envelope. However, if the position of the controller is between 9 and 12 o'clock, the envelope is set to type AR (Attack-Release). In this area, the gate length of the step is evaluated and has an influence on the length of the envelope.

The graphic illustrates the behavior of the controller:

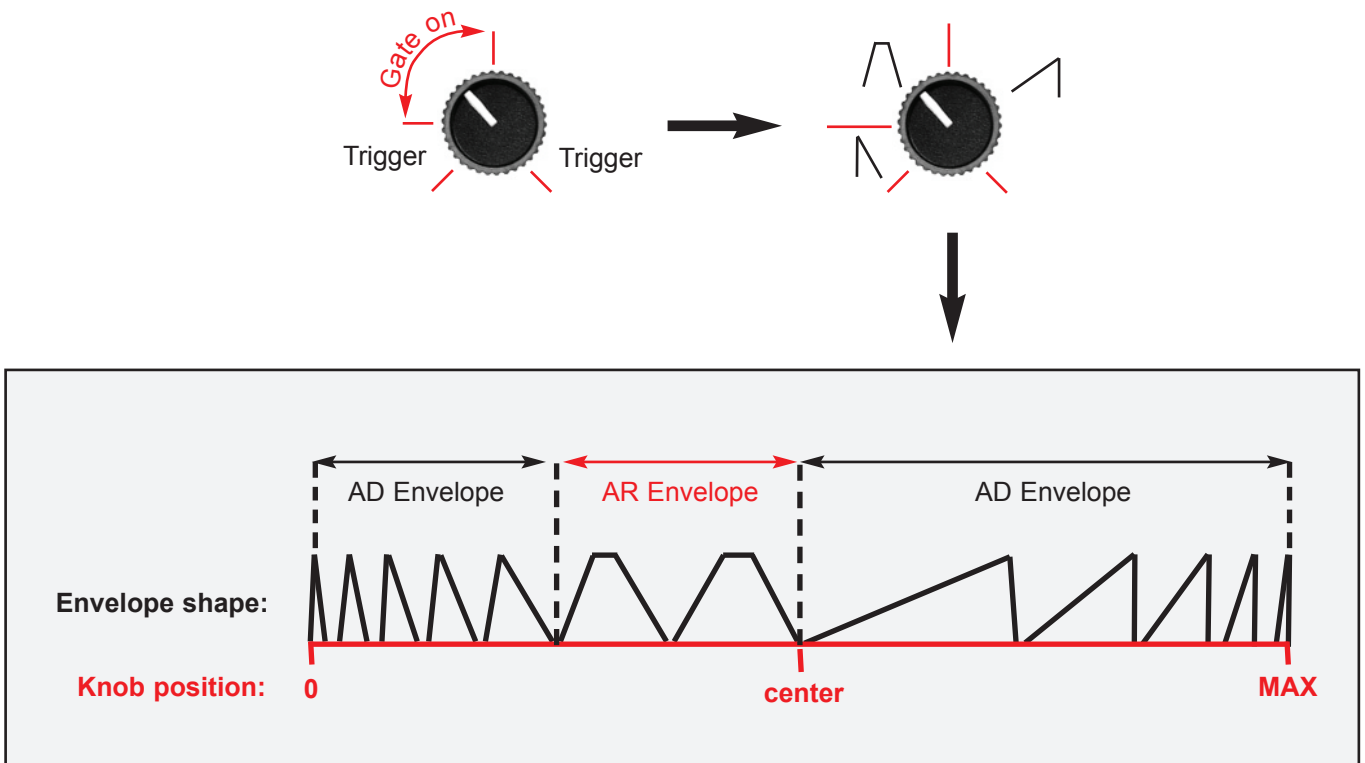

Effect of the knob on the attack and decay/release times
(0=left stop MAX=right stop)

The function of the controller can also be automatically modulated by a CV. The CV input "ENVELOPE" is available for this. The input is designed for voltages in the range 0 to +5v.

KNOB VARIATION

With the middle controller "VARIATION" the intensity of random changes in volume and envelope times can be regulated. This varies a running sequence, and more lively playback patterns or variations of the sequence result. When the control is set to ZERO, the pattern is played back unchanged.

The following parameters are affected: volume (volume of the step), decay times and release times.

KNOB FILL

The third control "FILL" regulates all VCAs evenly until the maximum volume of all channels is reached ("filling the channels"). This happens in addition to the playing sequence. The sequence continues to be heard until the maximum is reached. The effect can be compared to the dry-wet behavior of the MIX controller, where the original signal and the effect signal are mixed. Here, however, the sequence and the uniform low or high level of all filter bands are mixed.

The graphic below illustrates the effect:

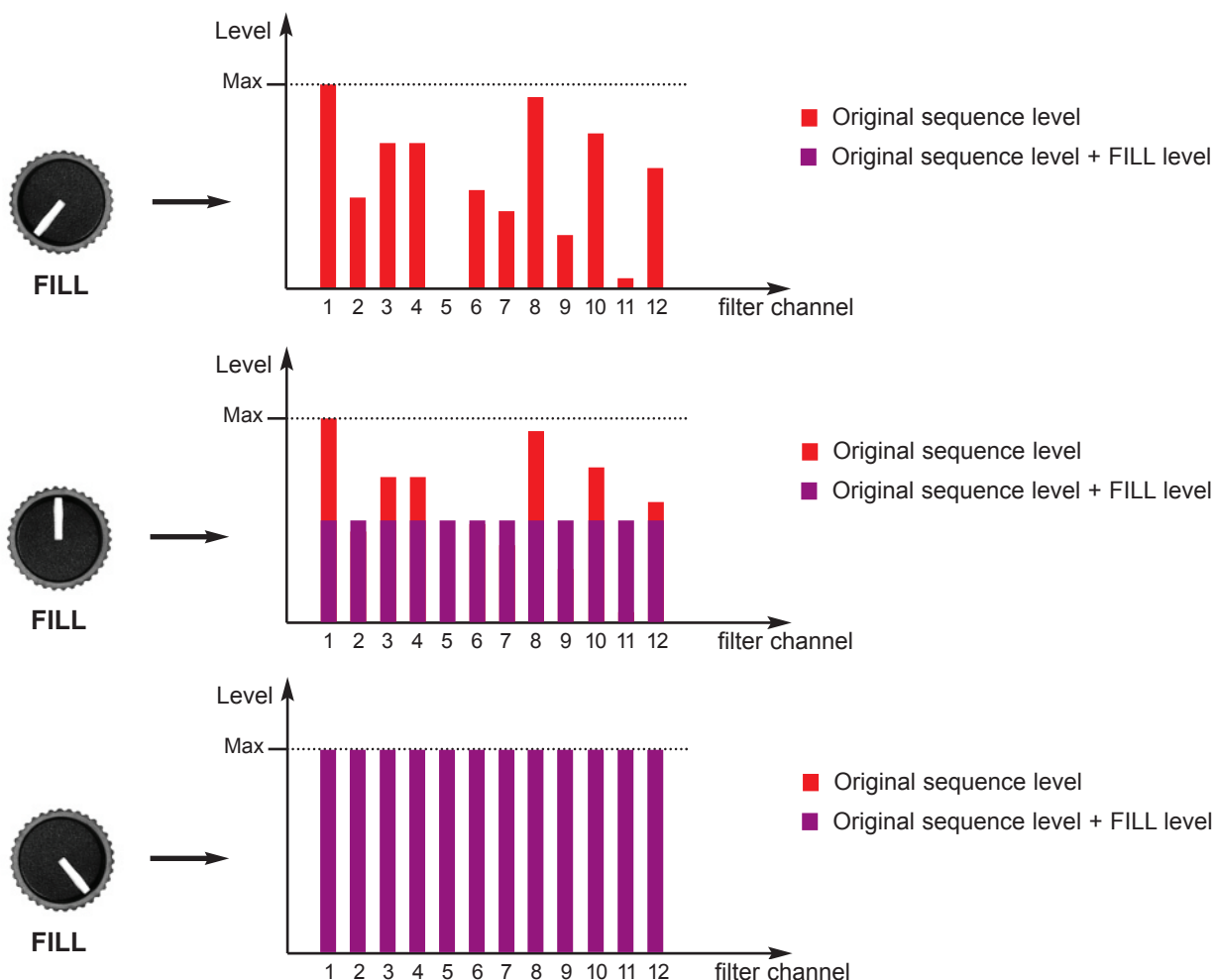

3.5 MODE MANUALLY

When the modulation sequencer is disabled, the filter bank can generate filter simulations. The individual filter bands are then controlled in such a way that classic filter profiles are generated. These are controlled with the knobs Envelope, Variation and Fill.

ACTIVATE MANUALLY MODE:

Use the “<” button to set the sequence to “oF” (possibly press several times!).

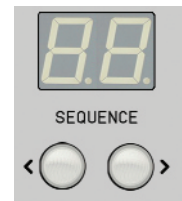

In this mode, the controllers have the following functions:

Knob ENVELOPE: SMOOTH = Smoothing of passing through the filter bands

Knob VARIATION: FILTER TYPE = selection of one of 6 filter types

Knob FILL: CUTOFF = Adjust filter type cutoff

FILTERTYPE

The VARIATION control sets one of six filter types. These algorithms use the filter bands to simulate classic filter types such as lowpass, bandpass, highpass and other types. This is possible because each filter band has its own VCA (Voltage Controlled Amplifier) that controls the volume of that band separately. For example, if you slowly increase and decrease the volume of the channels, starting from the band with the lowest frequency, you get a classic low-pass filter.

The following filter types can be set:

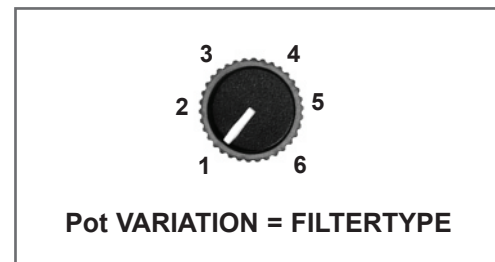

1 - All channels

- all bands are turned up simultaneously

2 - Lowpass



3 - Bandpass (1channel)



4 - Bandpass (2 channels)



5 - Bandpass (3 channels)



6 - Highpass



CUTOFF

The FILL control is used to change the filter cutoff frequency. As you turn the knob, the LEDs indicate the active area of the filter. The filter characteristics can also be seen visually. Only the filter bands with lit LED are audible.

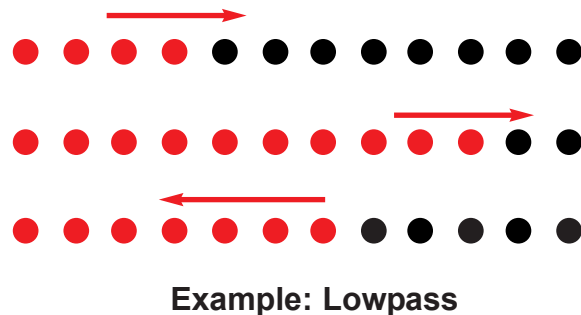
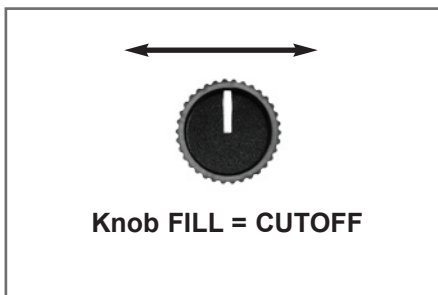

EXAMPLE OF FILTER MODULATION

Example: Adjusting the lowpass cutoff manually

- Set the CUTOFF (FILL knob) to the middle position
- Set FILTERTYPE to Lowpass (VARIATION knob at 9 o'clock).
- Turn SMOOTH to maximum (ENVELOPE knob fully clockwise)

Now you can use the CUTOFF control (FILL control) to move smoothly through the individual filter bands like a low-pass filter. You can see this from the glowing LEDs of the filter channels. The filter type algorithm automatically regulates the volume of the individual filter bands, creating the effect of a low-pass filter. The other filter types work the same way. Try them out and listen to the different effects.

SMOOTH

The ENVELOPE knob changes the smoothing of the band sweep with the cutoff control. It can be softly blended from unsmooth to smooth. With an unsmoothed setting, the bands jump straight on. With a smooth setting, the bands flow smoothly into one another.

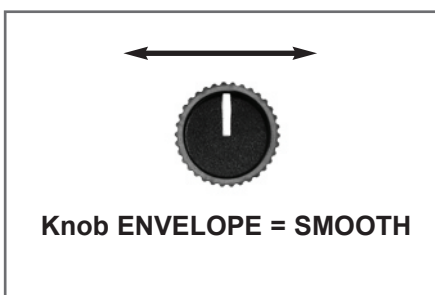

All three functions can also be controlled via the corresponding CV inputs.

4. MIDI FUNCTIONS

4.1 Overview

The module has extensive MIDI functions. The following MIDI commands can be used:

MIDI-CLOCK Start/Stop:	Sequencer clocking
Note Numbers:	Triggering the filter bands
Program Change:	Selection of a sequence
Control Change:	Controlling CURVES parameters
Sysex:	Load sequence pattern, firmware update

4.2 SYNC per MIDI

Connect a computer with MIDI interface and sequencer software, or a MIDI device (e.g. drum machine) that can send MIDI Clock/Start/Stop.

The CURVES sequencer can only run as a slave with MIDI clock. MTC (MIDI Time Code) or position data (such as Song Position Pointer) is not recognized.

4.3 Play filter channels with note commands

Each filter channel can be played with an external keyboard, for example. A note number is assigned to each filter band for this purpose. Velocity affects the triggered volume of the filter band.

Default notes for the filter bands are note numbers 36-47 on MIDI channel 1.

With the CURVES sequence editor, the note numbers and the MIDI channel can be changed.

4.4 Program Change (Select sequence pattern)

The module understands program change commands on the set MIDI receive channel (default: 1). The numbers correspond to the sequence numbers, i.e. 1 to 99.

If a program change command is received while the sequencer is running, the pattern is changed at the next ONE. If the sequencer is stopped, the pattern is switched immediately.

4.5 Parameter control via Control Change

Control change numbers are permanently assigned to all digital functions. The parameters are controlled with a value between 0 and 127. The controllers are received on the set MIDI receive channel.

Function	Control change number
ENVELOPE_ALL	2
FIL	1
VARIATION	3
VCA_BAND1	4
VCA_BAND2	8
VCA_BAND3	9
VCA_BAND4	10
VCA_BAND5	11
VCA_BAND6	12
VCA_BAND7	13
VCA_BAND8	14
VCA_BAND9	15
VCA_BAND10	16
VCA_BAND11	17
VCA_BAND12	18
ENV_BAND1	19
ENV_BAND2	20
ENV_BAND3	21
ENV_BAND4	22
ENV_BAND5	23
ENV_BAND6	24
ENV_BAND7	25
ENV_BAND8	26
ENV_BAND9	27
ENV_BAND10	28
ENV_BAND11	29
ENV_BAND12	30

4.6 Load sequences via sysex

Sequence patterns can be loaded into the module via SYSEX. The CURVES editor can be used for this. The note numbers and the MIDI receive channel can also be changed with the editor.

5. FIRMWARE UPDATE

You can easily update the firmware with a MIDI sysex dump. To do so, use a MIDI-sysex-dump-loader for example the freeware MIDI-OX or Electron C6 (win or mac).

1. Load the firmware sysex file to your computer.
2. Connect the MIDI interface of the computer with the MIDI input of the modul.
Therefore you have to use the provided MIDI adapter accessory.
3. Hold down both sequence keys while you power on the module.
The display shows “**UP**” (UPDATE).
4. Now send the Sysex firmware file to the module. While the update runs you can see the progress indicator (display shows counting numbers). The upload during time is for instance 1,5 minutes.
5. After the update procedure the module reboots automatically

After power on the display shows the current firmware:

- U0 (for version 0) or
- U1 (for version 1) or
- U2 (for version 2) ...

ADVICE:

Sometimes it's necessary to set the parameter “Delay” or “Timeout” to higher values (such as 80ms) from your used dumper software.

6. Appendix

6.1. Technical details

Connections:

Ribbon cable adapter for Doepfer bus +/-12Volt

Current consumption: max. +250mA / - 170 mA

Size: Euro rack format 3U / 31HP 157x128,5x40mm

6.2 Warrenty

Beginning from the date of purchase a 2-year warranty is guaranteed for this device in case of any manufacturing errors or other functional deficiencies during runtime. The warranty does not apply in case of:

- damage caused by misuse
- mechanical damage arising from careless treatment (dropping, vigorous shaking, mishandling, etc)
- damage caused by liquids penetrating the device
- heat damage caused by overexposure to sunlight or heating
- electric damage caused by improper connecting
(wrong power supply/ jacks/ MIDI connections/ voltage problems).

If you have any complaints please contact your dealer or send an e-mail to:

service@flame-instruments.de

6.3 Terms of production

conformity: CE, RoHS, UL

6.4 Disposal

The device is produced with RoHS-conformity (subject to the regulations of the European Union) and is free of hazardous substances (like mercury, plumb, cadmium and hexavalent chrome). But electronical scrap is hazardous waste. Please don't add this to consumer waste. For an environment friendly disposal of waste please contact your distributor or specialist dealer.

6.3 Support

Updated and additional informations, updates, downloads and more see:

www.flame-instruments.de

6.4 Acknowledgment

For help and assistance big thanks to: Alex4 und Schneiders Büro Berlin, Shawn Cleary (Analogue haven, Los Angeles), Thomas Wagner, Robert Junge, Anne-Kathrin Metzler, Lena Büniger, Alex Wolter und Sebastian Preller.